

# LED LANDSCAPE LIGHTING

FLL-217/HH  
FLL-225S  
FLL-226E



FLL-217/HH



FLL-225S



FLL-226E

Landscape lighting environment has been transformed. Utilizing performance optics and long lasting driver, these landscape lights will last for years to come. With various optics available, this luminaire can be focus in a narrow beam or wide beam. Die-cast aluminum provides the fittings a rugged protection against the elements.

**DDE Inc.**  
288 Club Dr.  
San Carlos, CA 94070

888-271-0644  
[www.ddeonline.com](http://www.ddeonline.com)  
[sales@ddeonline.com](mailto:sales@ddeonline.com)

**FLL-217/HH**  
**FLL-225S**  
**FLL-226E**

# LED LANDSCAPE LIGHTING



FLL-217/HH



FLL-225S



FLL-226E

## Applications

Ideal for backyards, parks, garden & signs.

## Features

- UL and CUL listed for WET LOCATIONS.
- Die-cast aluminum housing.
- Durable powder coating weatherproof paint.
- Integral glare shield and tempered lens.
- Included easy mounting 1/2" threaded nipple and lock washer.
- Stainless hardware on all the units.
- Various options for available for all environments.

## Dimensions

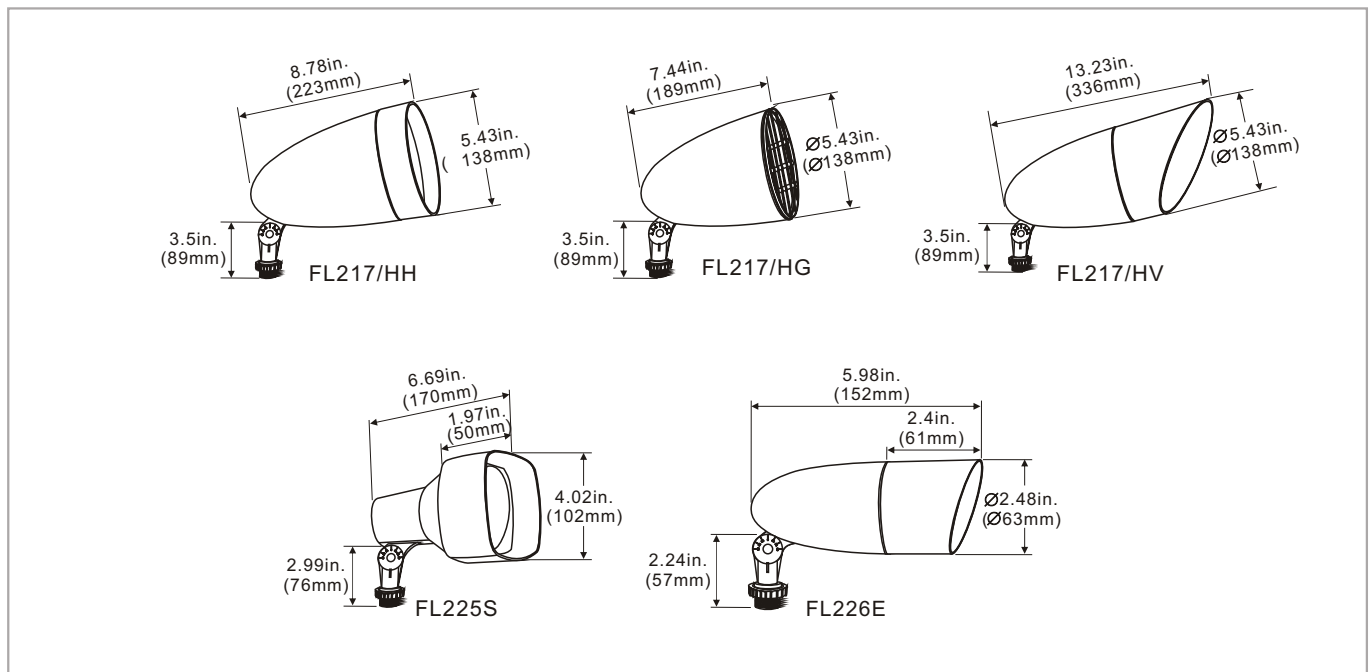

# Technical Specifications

## FLL-217/HH

- \* Die cast housing
- \* Architectural bronze UV resistant powder coat finish
- \* UL listed / CUL listed
- \* Input voltage: 120~277V AC
- \* Highest quality long life LEDs
- \* Low Tj for long life, low lumen depreciation
- \* FLL-217/HH Input power-16Watts
- \* Lumens — 1000
- \* Low starting temp -30°C
- \* Color temperature — 4700K ( other K values optional)
- \* IC current controlled LED circuits
- \* Various optics available

## FLL-225S

- \* Die cast housing
- \* Architectural bronze UV resistant powder coat finish
- \* UL listed / CUL listed
- \* Input voltage: 120~277V AC
- \* Highest quality long life LEDs
- \* Low Tj for long life, low lumen depreciation
- \* FLL-225S Input power-12Watts
- \* Lumens — 750
- \* Low starting temp -30°C
- \* Color temperature — 4700K ( other K values optional)
- \* IC current controlled LED circuits
- \* Various optics available

## FLL-226E

- \* Die cast housing
- \* Architectural bronze UV resistant powder coat finish
- \* UL listed / CUL listed
- \* Input voltage: 120~277V AC
- \* Highest quality long life LEDs
- \* Low Tj for long life, low lumen depreciation
- \* FLL-226E Input power-5Watts
- \* Lumens — 400
- \* Low starting temp -30°C
- \* Color temperature — 4700K ( other K values optional)
- \* IC current controlled LED circuits
- \* Various optics available

## Landscape Lighting Series Hood Covers(For FLL-217 only)

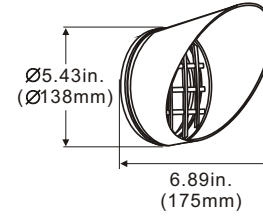
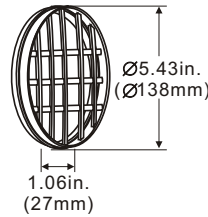
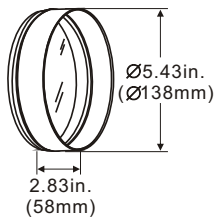

## Accessories

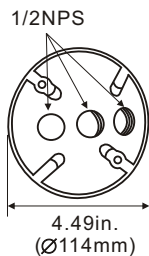

**OB-003**  
Junction Box

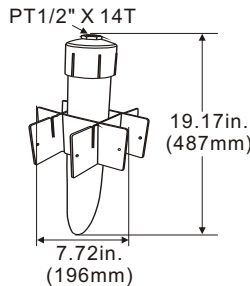

**GRP-320-G1**  
PVC Pipe

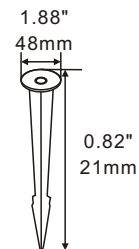

**AB-007**  
Die-cast stake



FLL-217/HH



FLL-225S



FLL-226E



**DDE Inc.**  
288 Club Dr.  
San Carlos, CA 94070

888-271-0644  
[www.ddeonline.com](http://www.ddeonline.com)  
[sales@ddeonline.com](mailto:sales@ddeonline.com)