

Item No.: AR822-SF



Applications

For walkways, driveways, tennis courts, malls, shopping centers, commercial and industrial complexes, residential areas, and parkway lighting.

Specification Features

- UL and CUL listed for wet location
- Heavy duty die-cast aluminum housing
- Heat and impact resistant tempered glass lens
- Standard with mogul base socket-E39, 4KV, UL approved
- Polyester powder paint finish standard for architectural metallic bronze finish
- A silicone gasket for weather seal
- Ideal for HPS and MH 1000 Watts Max

Engineering Dimensions

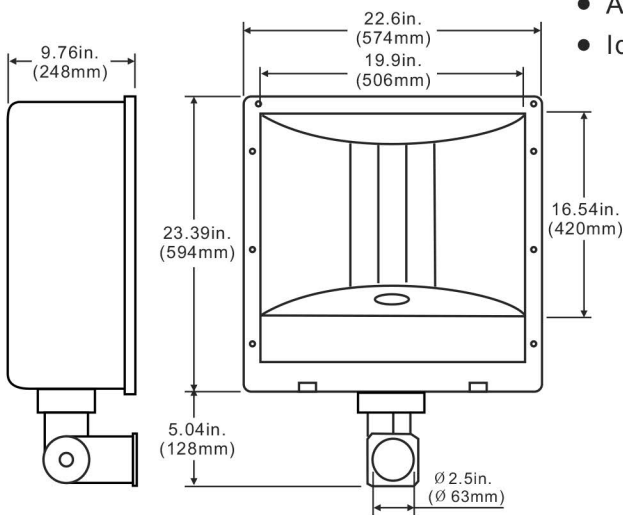

Line Drawing

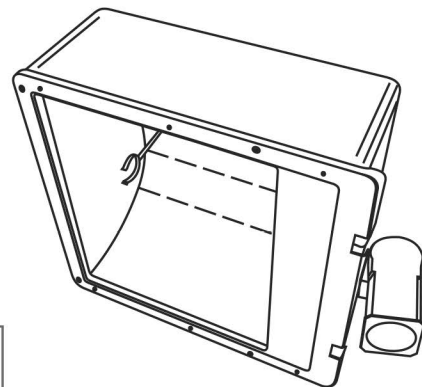

Assembly Parts



Vandal Shield

Wire Guard

Visor

Packing Information

Weights	Cubit Feet	Master Carton Qty	40' Container Qty
38.98LBS	4.434'	1 PC	450 PCS